

Transient Voltage Suppressor

Features

- 450 watts peak pulse power ($t_p = 8/20\mu s$)
- Response Time is Typically $< 1\text{ ns}$
- Protects one bidirectional line or two unidirectional lines
- Working Voltages: 24V
- Low clamping voltages
- AEC-Q101 Qualified

IEC COMPATIBILITY (EN61000-4)

- IEC 61000-4-2 (ESD) $\pm 30\text{kV}$ (air), $\pm 30\text{kV}$ (contact)
- IEC 61000-4-4 (EFT) 40A (5/50ns)
- IEC 61000-4-5 (Lightning) 8A (8/20 μs)

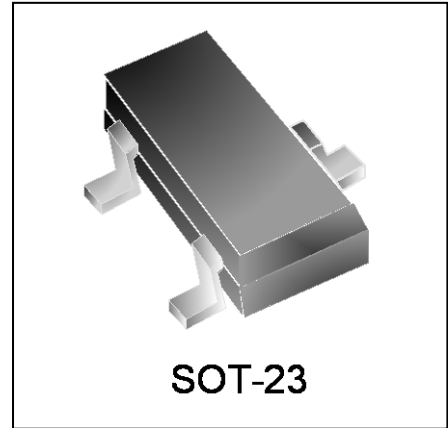

Mechanical Characteristics

- JEDEC SOT-23 package
- Molding compound flammability rating:
- UL 94V-0
- Marking : Marking Code
- Packaging : Tape and Reel per EIA 481
- RoHS Compliant

Applications

- Automotive Networks
- Control & Monitoring Systems
- Portable Electronics
- Set-Top Box
- Servers, Notebook, and Desktop PC
- Wireless Bus Protection

Circuit Diagram

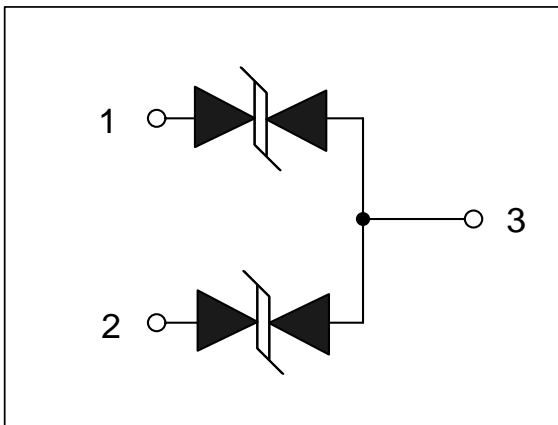

Schematic & PIN Configuration

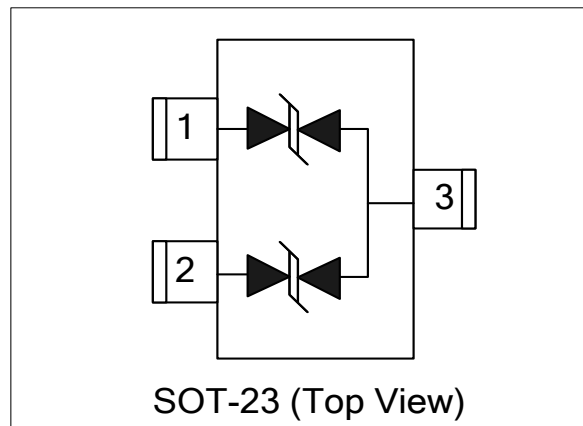

Absolute Maximum Rating			
Rating	Symbol	Value	Units
Peak Pulse Power ($t_p=8/20\mu s$)	P_{PP}	450	Watts
Peak Pulse Current ($t_p=8/20\mu s$)	I_{PP}	8	A
Operating Temperature	T_J	-55 to +125	$^{\circ}C$
Storage Temperature	T_{STG}	-55 to +150	$^{\circ}C$

Electrical Parameters (T=25 $^{\circ}C$)

Symbol	Parameter
I_{PP}	Reverse Peak Pulse Current
V_C	Clamping Voltage @ I_{PP}
V_{RWM}	Reverse Stand-Off Voltage
I_R	Reverse Leakage Current @ V_{RWM}
V_{BR}	Breakdown Voltage @ I_T
I_T	Test Current

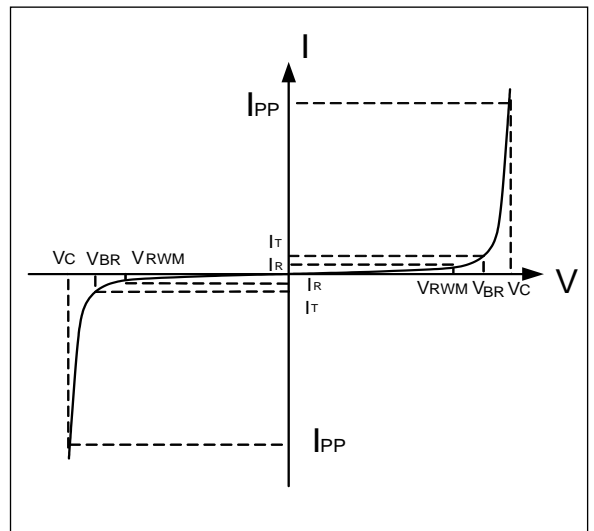

Electrical Characteristics

PESD1CAN						
Parameter	Symbol	Conditions	Minimum	Typical	Maximum	Units
Reverse Stand-Off Voltage	V_{RWM}				24	V
Reverse Breakdown Voltage	V_{BR}	$I_T=1mA$	26..7			V
Reverse Leakage Current	I_R	$V_{RWM}=24V, T=25^{\circ}C$			200	nA
Clamping Voltage	V_C	$I_{PP}=8A, t_p=8/20\mu s$		50	54	V
Dynamic Resistance ^{1,2}	R_{DYN}	TLP=0.2/100ns		0.4		Ω
ESD Clamping Voltage ¹	V_C	$I_{PP} = 4A, t_p = 0.2/100ns$ (TLP)		38.0		V
ESD Clamping Voltage ¹	V_C	$I_{PP} = 16A, t_p = 0.2/100ns$ (TLP)		43.0		V
Junction Capacitance	C_j	Pin 1 to 3 or Pin 2 to 3 $V_R = 0V, f = 1MHz$		25	35	pF

Notes : 1、 TLP Setting : $t_p=100ns, t_r=0.2ns, I_{TLP}$ and V_{TLP} sample window: $t_1=70ns$ to $t_2=90ns$.
 2、 Dynamic resistance calculated from $I_{PP}=4A$ to $I_{PP}=16A$ using "Best Fit"

Typical Characteristics

Figure 1: Peak Pulse Power vs. Pulse Time

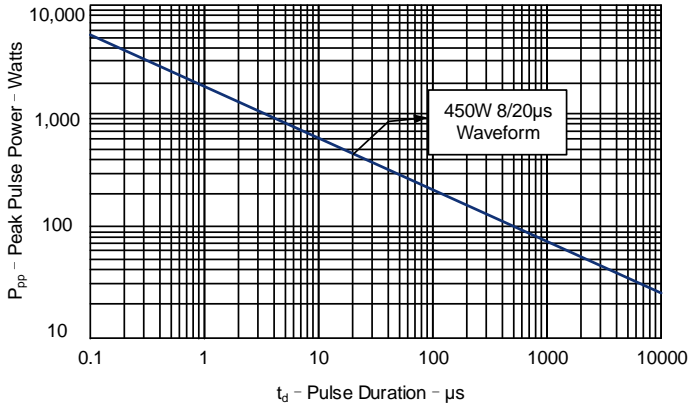

Figure 2: Power Derating Curve

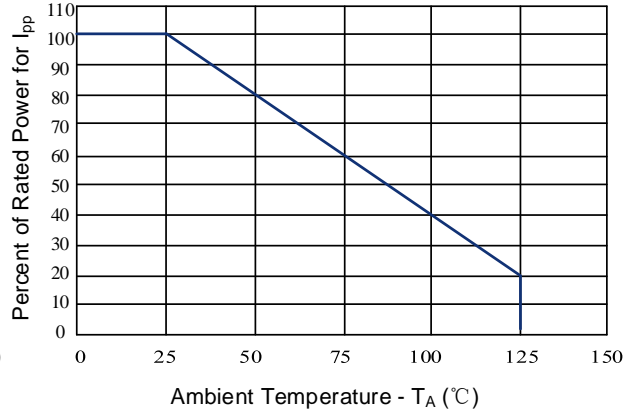

Figure 3: Clamping Voltage vs. Peak Pulse Current

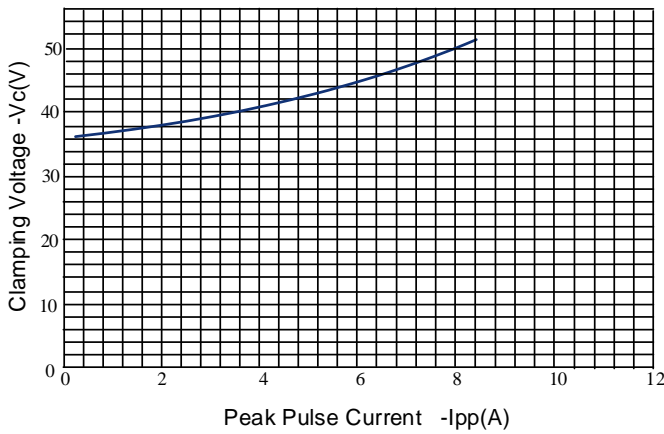

Figure 4: Normalized Junction Capacitance vs. Reverse Voltage

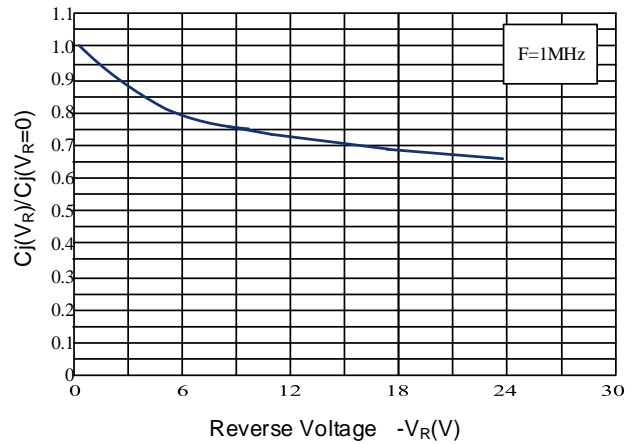

Figure 5: 8/20µs Pulse Waveform

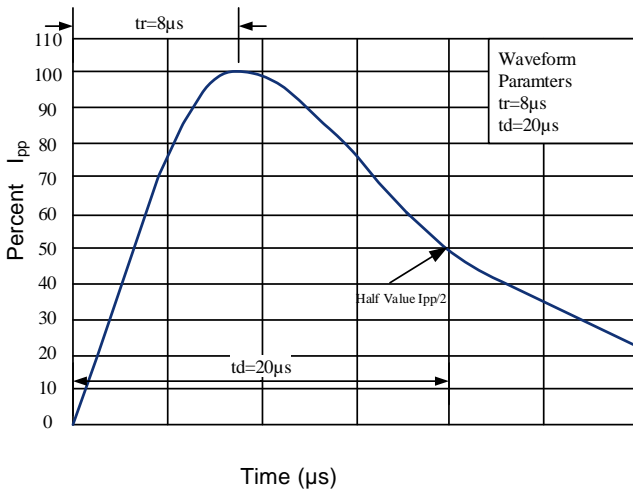
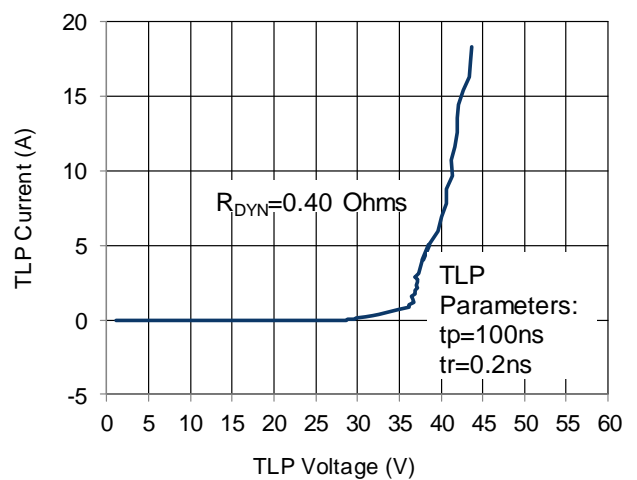
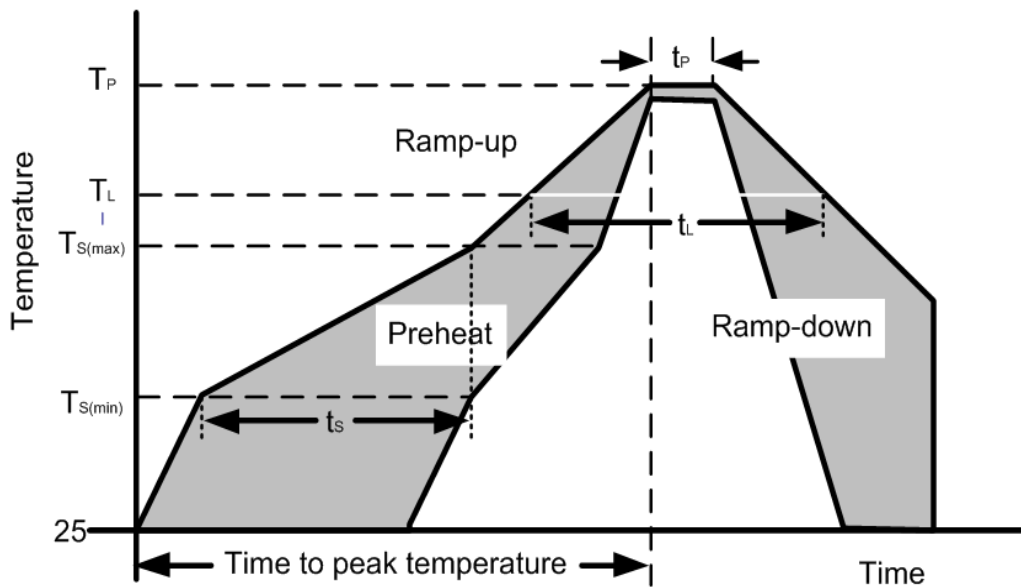

Figure 6: TLP I-V Curve



Soldering Parameters

Reflow Condition		Pb – Free assembly
Pre Heat	Temperature Min ($T_{s(min)}$)	150°C
	Temperature Max ($T_{s(max)}$)	200°C
	Time (min to max) (t_s)	60 – 190 secs
Average ramp up rate (Liquidus Temp) (T_L) to peak		5°C/second max
$T_{s(max)}$ to T_L —Ramp-up Rate		5°C/second max
Reflow	Temperature (T_L) (Liquidus)	217°C
	Temperature (t_L)	60 – 150 seconds
Peak Temperature (T_P)		260+0/-5 °C
Time within actual peak Temperature (t_p)		20 – 40 seconds
Ramp-down Rate		5°C/second max
Time 25°C to peak Temperature (T_P)		8 minutes Max.
Do not exceed		280°C



Outline Drawing – SOT-23

PACKAGE OUTLINE

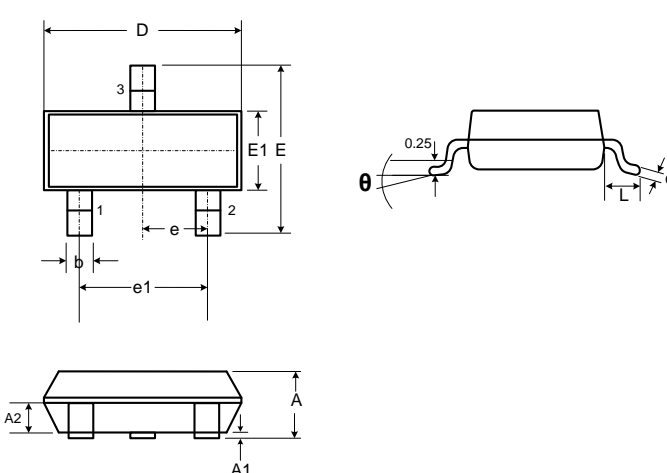

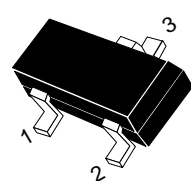

SOT-23

DIMENSIONS				
SYMBOL	MILLIMETER		INCHES	
	MIN	MAX	MIN	MAX
A	0.90	1.15	0.035	0.045
A1	0.00	0.10	0.000	0.004
A2	0.60	0.70	0.0236	0.0275
b	0.30	0.50	0.012	0.020
c	0.08	0.15	0.003	0.006
D	2.80	3.00	0.110	0.118
E	2.25	2.55	0.089	0.100
E1	1.20	1.40	0.047	0.055
e	0.95 BSC		0.0374 BSC	
e1	1.80	2.00	0.071	0.079
L	0.30	0.50	0.012	0.020
θ	0	8°	0	8°

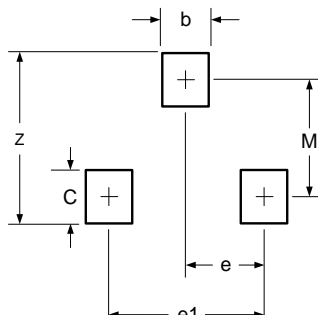

DIMENSIONS		
DIM	INCHES	MILLIMETERS
M	0.0795	2.02
C	0.0315	0.80
Z	0.111	2.82
e	0.037 BSC	0.95 BSC
e1	0.075 BSC	1.9 BSC
b	0.0315	0.80

Notes

1. Dimensioning and tolerances per ANSI Y14.5M, 1985.
2. Controlling Dimension: Inches
3. Pin 3 is the cathode (Unidirectional Only).
4. Dimensions are exclusive of mold flash and metal burrs.

Marking Codes

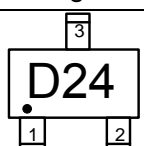
Part Number	Marking Code
PESD1CAN	

Package Information

Qty: 3k/Reel